

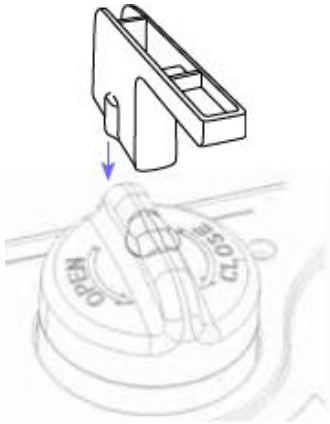





BIBO Classic – Replacing the Maxi Filter Cartridge

1. Remove the lid on top of the BIBO by simply lifting it off. It is best to lift the lid from the back first.
2. You will see the white top of the Maxi Filter Cartridge towards the back of your BIBO with a handle protruding from it. Using the filter spanner provided, turn the filter firmly anti-clockwise until the filter cartridge releases.



3. Pull the cartridge up and out of the BIBO.
4. Remove the new Maxi Filter Cartridge from its packaging and insert it.
5. Using the filter spanner provided, turn the filter firmly clockwise.

Once the Maxi Filter Cartridge has been replaced you will need to reset the countdown timer in your BIBO.

1. Press the white menu key once 
2. Press the red cup key 5 times  (Your screen will show the heading 'UV/Filter Replacement')
3. Press the white menu key once to enter the UV/Filter replacement menu 
4. Press the white menu key once to enter the Filter replacement menu 
5. Press the white menu key once to confirm the replacement of the filter 
6. A Blue 'OK' will flash up and counter should now read '180 days left'
7. You have successfully reset the countdown timer. Wait 30 seconds and the menu will automatically revert back to your home screen

BIBO Classic – Replacing the UV Lamp



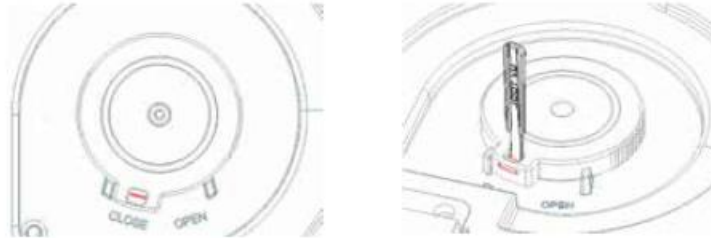

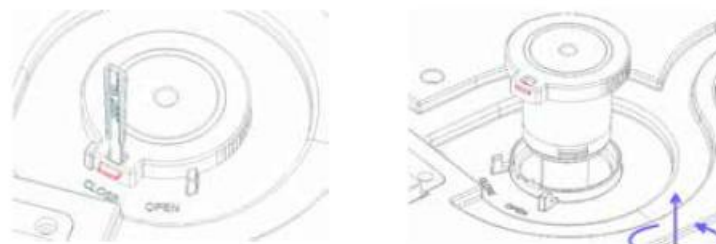

1. Remove the lid on top of the BIBO by simply lifting it off. It is best to lift the lid from the back first.
2. You will see the white cap of the UV Lamp towards the front of your BIBO. Insert the UV Lamp key provided into the slot, release the latch and rotate the UV Lamp anti-clockwise to the 'open' position.



3. Pull the UV Lamp up and out of the BIBO.
4. Remove the new UV Lamp from it's packaging and inset it carefully.
5. Rotate the UV Lamp clockwise into the 'Close' position. It will click and lock into place.



Once the Maxi Filter Cartridge has been replaced you will need to reset the countdown timer in your BIBO.

1. Press the white menu key once 
2. Press the red cup key 5 times  (Your screen will show the heading 'UV/Filter Replacement')
3. Press the white menu key once to enter the UV/Filter replacement menu 
4. Press the red cup key once to navigate across to the 'UV' option 
5. Press the white menu key once to enter the UV replacement menu 
6. Press the white menu key once to confirm the replacement of the UV lamp 
7. A Blue 'OK' will flash up and counter should now read '360 days left'
8. You have successfully reset the countdown timer. Wait 30 seconds and the menu will automatically revert back to your home screen

BIBO Bar – Replacing the Maxi Filter Cartridge

1. Remove the lid from the top of the BIBO Bar by lifting it from the back first.
2. At the back of the BIBO there's a blue tap in the white water pipe – twist this so that the lever is at right angles to the pipe then dispense at least 500ml of cold water.
3. You will see the white top of the Maxi Filter Cartridge towards the back of your BIBO with a handle protruding from it. Using the filter spanner provided, turn the filter firmly anti-clockwise until the filter cartridge releases.

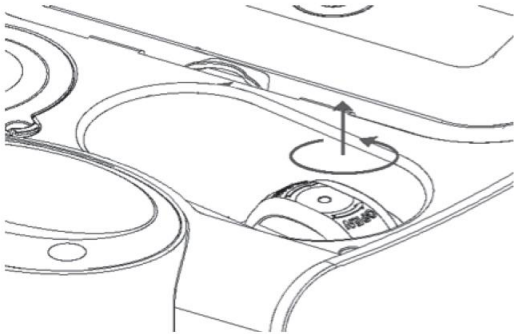

4. Pull the cartridge up and out of the BIBO.
5. Remove the new Maxi Filter Cartridge from its packaging and insert it.
6. Using the filter spanner provided, turn the filter firmly clockwise.
7. Turn the water supply to the BIBO back on by twisting the blue tap at the back of your BIBO so that the lever is in line with the white water pipe.